

Hardware connection diagrams

FB4

FB4 - Basic setup

We have a single laser projector connected to our PC via the Integrated FB4 hardware.

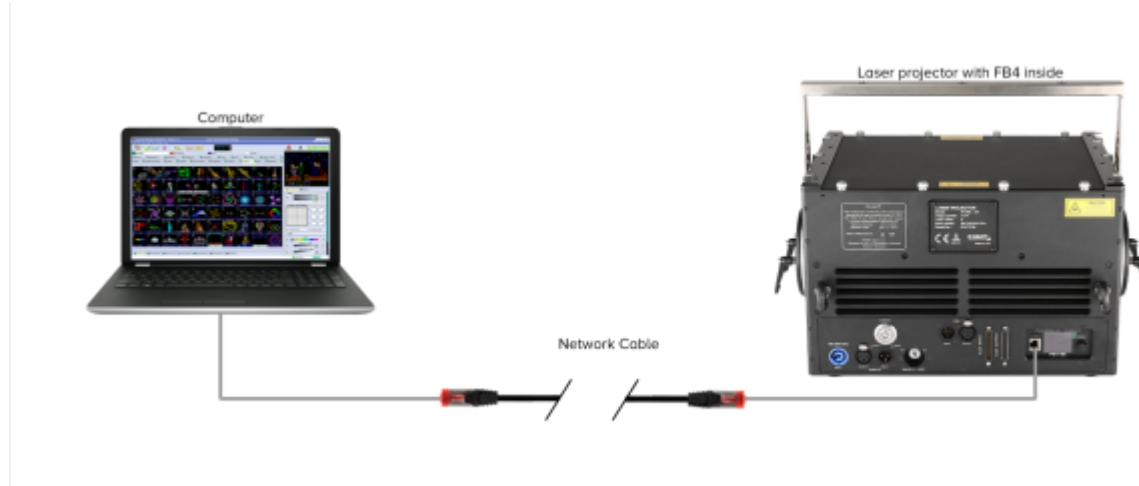

FB4 - Independent control setup

We have two lasers, each with their own FB4. This is called independent control, as each laser can do something different at the same time, because they each have their own hardware connection.

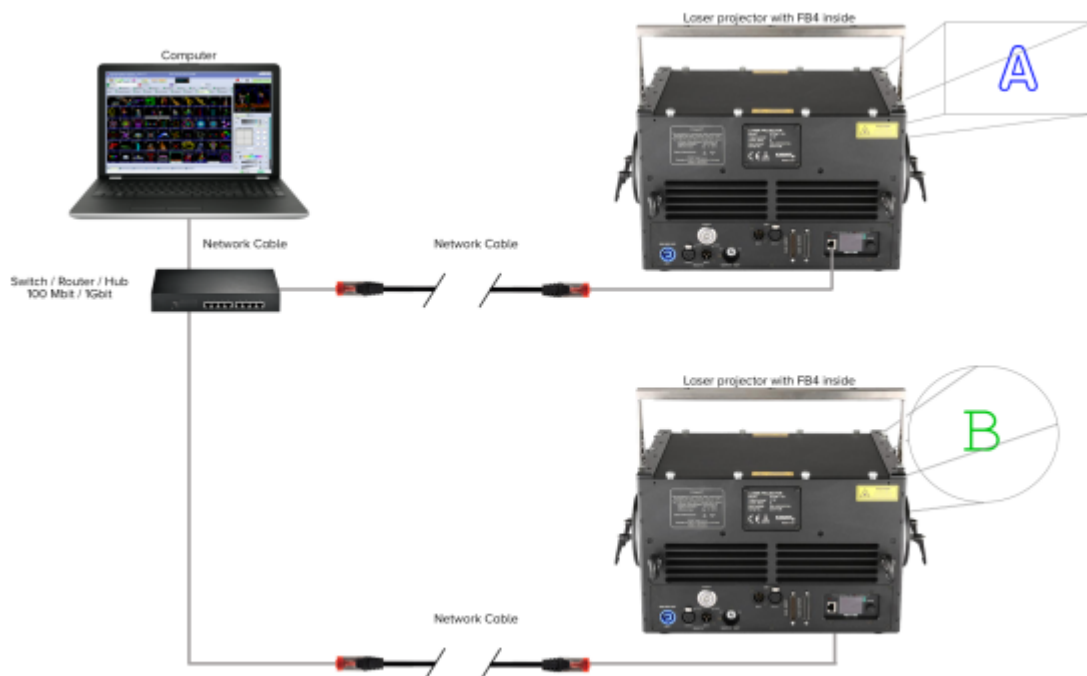

FB4 - Console setup

We have a single laser projector connected to a DMX console via the integrated FB4 OEM hardware through DMX or Ethernet. This example requires the FB4 DMX or FB4 MAX. The FB4 has been pre-populated with frames and can operate without computer. ❌

FB4 - Extended console setup

We have two laser projectors connected to a DMX console or computer via the integrated FB4 hardware interface through DMX or Art-net. These projectors have an onboard switch which allows you to daisy chain them. This example requires the use of a laser projector, purchased through Pangolin. When running from a PC, you can simple stream content to the device. When running from a console, the FB4 has been pre-populated with frames and can operate without computer.



FB4 External

FB4 External - Basic setup

We have a single laser projector connected to our PC via the FB4-External hardware.

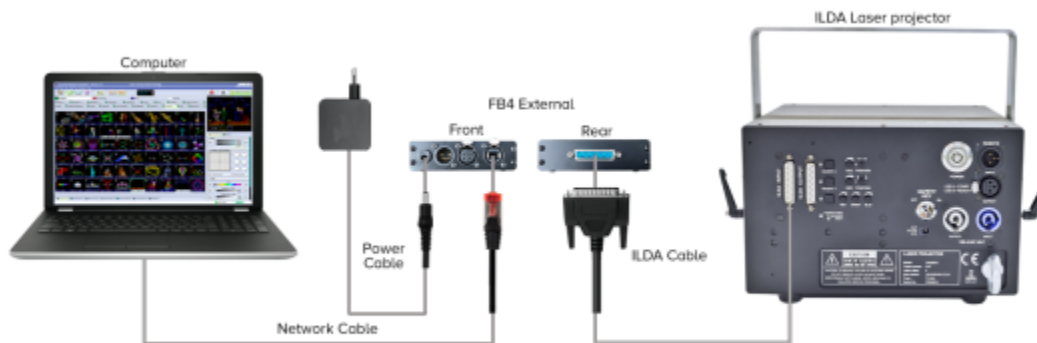

FB4 External - Shared control setup

We have two lasers connected to a computer. Then we split the ILDA signal to both lasers (daisy chain). This is called shared control. As such, both lasers will do the same thing at the same time.



FB4 External - Independent control setup

We have two lasers, each with their own FB4. This is called indecent control, as each laser can do something different at the same time, because they each have their own hardware connection.

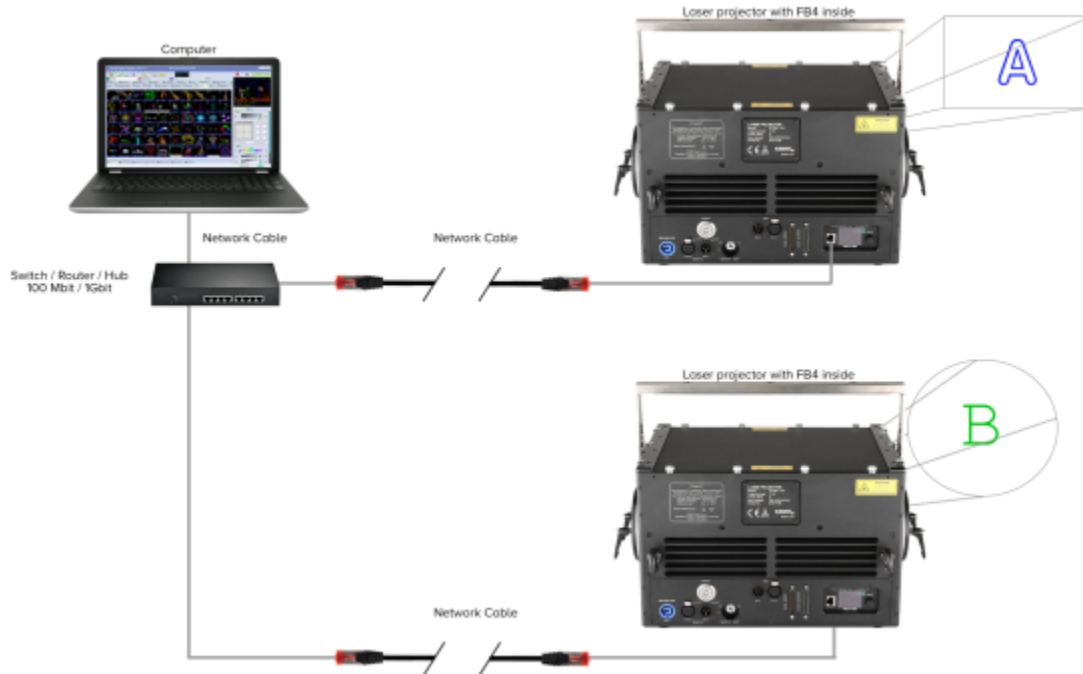

FB4 External - Console Setup

We have a single laser projector connected to a DMX console via the FB4-External hardware through DMX or Ethernet. The FB4 has been pre-populated with frames and can operate without computer.

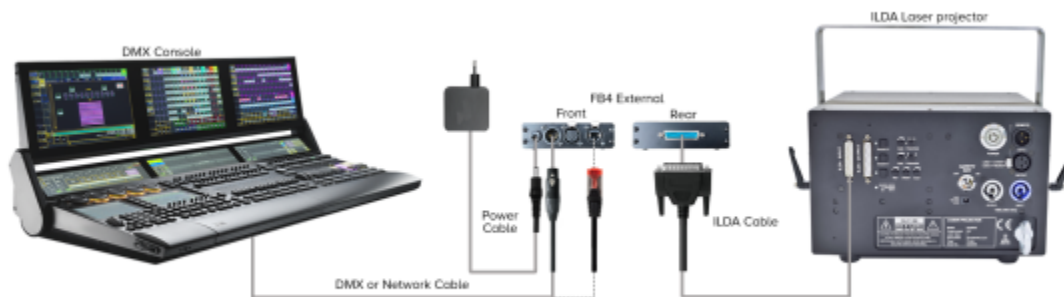

FB4 External - Independent Console Setup

We have two lasers, each with their own FB4. This is called indecent control, as each laser can do something different at the same time, because they each have their own hardware connection.

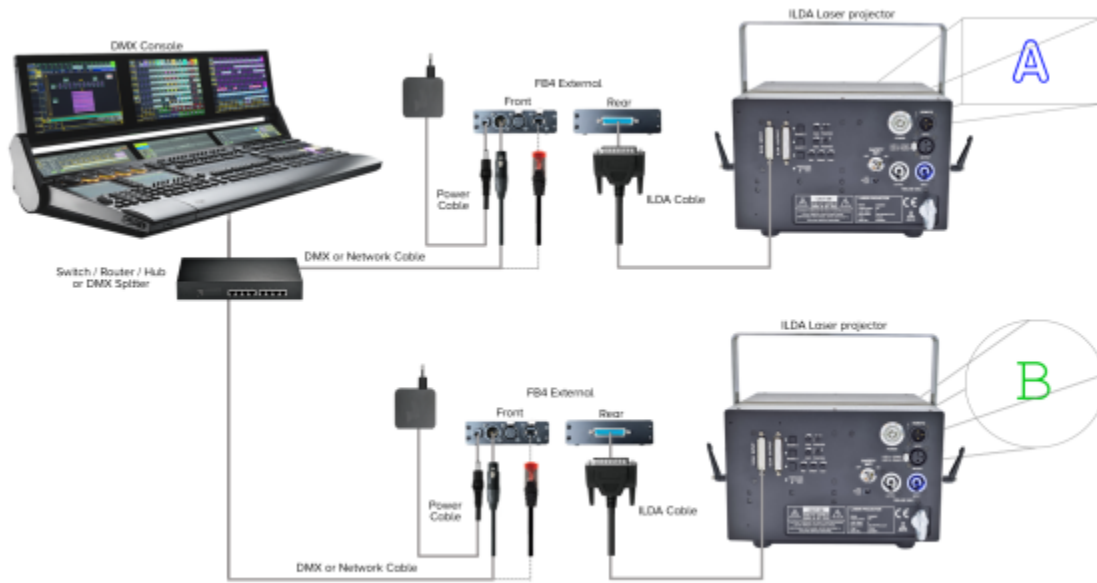

FB3

FB3 - Basic setup

In this setup we have a single laser projector connected to our PC via the FB3QS hardware.



FB3 - Shared control setup

We have two lasers connected to our PC via one FB3QS. Then we split the ILDA signal to both lasers (daisy chain). This is called shared control. As such, both lasers will do the same thing at the same time.



FB3 - Independent control setup

We have two lasers, each with their own FB3QS. This is called indecent control, as each laser can do something different at the same time, because they each have their own FB3QS connected.

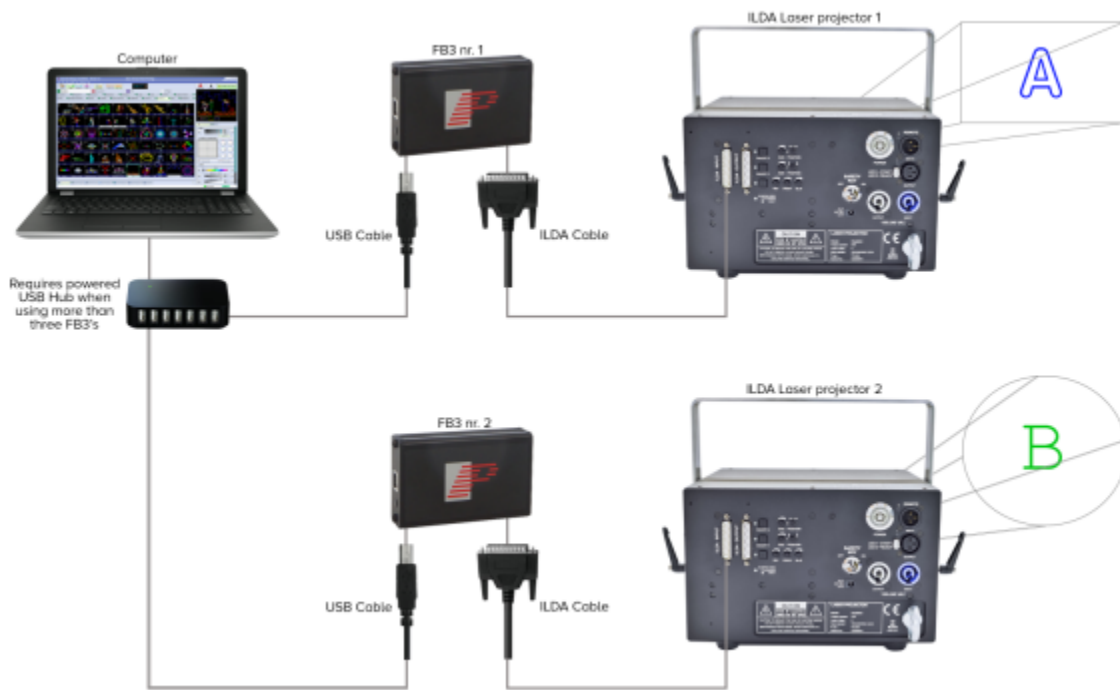

FB3 - Console setup

Here you can see a basic setup including a lighting console using a single laser projector. The same principles for shared and independent control mentioned above, apply here. Notice we have the ENTTEC connected to send our DMX signal.



FB3 - Midi control setup

Here you can see a basic setup including an APCMINI midi console using a single laser projector. The same principles for shared and independent control mentioned above, apply here.

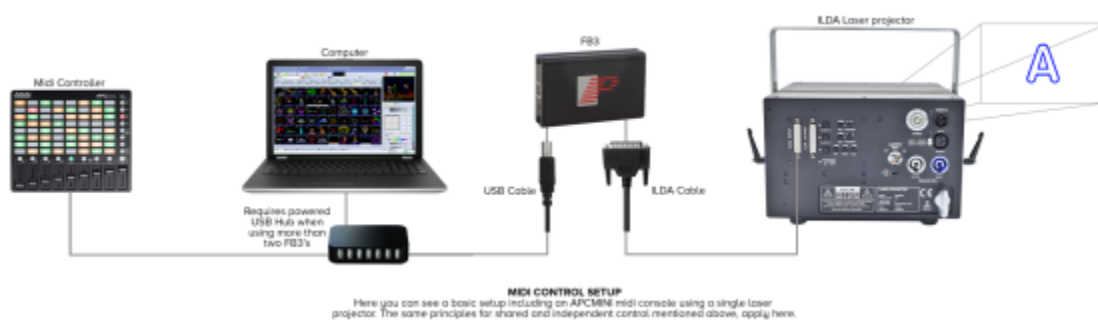

From:

<https://wiki.pangolin.com/> - Complete Help Docs

Permanent link:

<https://wiki.pangolin.com/doku.php?id=hardware:connection-diagrams&rev=1702565104>

Last update: 2023/12/14 15:45

